

# Bass30

AMP MODELING  
DIGITAL MULTI-EFFECT  
BASS SYSTEM



OWNER'S MANUAL

**DOD**

**H** A Harman International Company



These symbols are internationally accepted symbols that warn of potential hazards with electrical products. The lightning flash means that there are dangerous voltages present within the unit. The exclamation point indicates that it is necessary for the user to refer to the owners manual.

These symbols warn that there are no user serviceable parts inside the unit. Do not open the unit. Do not attempt to service the unit yourself. Refer all servicing to qualified personnel. Opening the chassis for any reason will void the manufacturer's warranty. Do not get the unit wet. If liquid is spilled on the unit, shut it off immediately and take it to a dealer for service. Disconnect the unit during storms to prevent damage.

### Electromagnetic Compatibility

Operation is subject to the following conditions:

- This device may not cause harmful interference.
- This device must accept any interference received, including interference that may cause undesired operation.
- Use only shielded interconnecting cables.
- Operation of this unit within significant electromagnetic fields should be avoided.

## Warning

**For your protection, please read the following:**

**Water and Moisture:** Appliances should not be used near water (e.g. near a bathtub, washbowl, kitchen sink, laundry tub, in a wet basement, or near a swimming pool, etc.) Care should be taken so that objects do not fall and liquids are not spilled into the enclosure through openings.

**Power Sources:** The appliance should be connected to a power supply only of the type described in the operating instructions or as marked on the appliance.

**Grounding or Polarization:** Precautions should be taken so that the grounding or polarization means of an appliance is not defeated.

**Power Cord Protection:** Power supply cords should be routed so that they are not likely to be walked on or pinched by items placed upon or against them, paying particular attention to cords at plugs, convenience receptacles, and the point where they exit from the appliance.

**Servicing:** To reduce the risk of fire or electrical shock, the user should not attempt to service the appliance beyond that described in the operating instructions. All other servicing should be referred to qualified service personnel.

**For units equipped with externally accessible fuse receptacle:** Replace fuse with same type and rating only.

## DECLARATION OF CONFORMITY

Manufacturer's Name: DOD Electronics  
Manufacturer's Address: 8760 S. Sandy Parkway  
Sandy, Utah 84070

declares that the product:

Product Name: Bass30

Product Options: All (requires a Class II power adapter that conforms to the requirements of EN60065, EN60742, or equivalent).

conforms to the following product specifications:

Safety: EN 60065 (1993)  
IEC65(1985) with Amendments 1, 2, 3

EMC: EN 55013 (1990)  
EN 55020 (1991)

Supplementary Information:

The product herewith complies with the requirements of the Low voltage directive 73/23/EEC and the EMC Directive 89/336/EEC as amended by directive 93/68/EEC.

DOD Electronics  
Vice President of Engineering  
8760 S. Sandy Parkway  
Sandy, Utah 84070, USA  
Effective (8/17/99)

European Contact: Your local DOD Sales and Service or  
Harman Music Group  
8760 S. Sandy Parkway  
Sandy, Utah, USA  
Tel: (801) 568-7638  
Fax: (801) 568-7642

# Table of Contents

Safety Information.....	I
Declaration of Conformity...	II
Table of Contents.....	III

## Introduction

Congratulations.....	1
Included Items.....	1
Features.....	1

## Section One

A Guided Tour.....	2
Front Panel.....	2
Rear Panel.....	5
Getting Started.....	6
Making Connections.....	6

## Section Two

Performance Mode.....	8
Selecting a Preset.....	8
Data Wheel.....	8
Footswitches.....	9
Accessing the Tuner.....	10
Jam-A-Long.....	11

## Section Three

Editing a Preset.....	12
User Interface.....	12
Expression Pedal.....	15
Storing/Copying.....	17

## Section Four

Effect Definitions.....	18
Compressor/Limiter.....	18
Wah/AutoWah.....	18
Modeling.....	18
Fretless.....	19
Bass Synth.....	19
Noise Gate.....	20
Mod/Pitch.....	20
Delay.....	21
Phrase Sampler.....	22
Reverb.....	23
Parameter Definitions.....	23

## Section Five

Creating a Preset.....	26
------------------------	----

## Section Six

Resetting the Bass30.....	30
Pedal Calibration.....	31
Maintenance.....	31

## Section Seven

Warranty.....	32
Specifications.....	33

# Introduction

## Congratulations!

You are now the proud owner of the Bass30 complete Bass Guitar system. The Bass30 is an extremely powerful tool capable of producing virtually any sound that you can imagine. It offers Amp/Guitar Modeling, Bass Synthesis, and a host of great sounding effects including: Frequency Selective Compression, Distortion, Equalization, Noise Gate, Chorus, Flanger, Phaser, Vibrato, Pitch Shifter, Pitch Bending, Bass Enhancer, Detuner, Enveloped Effects, Wah, Auto Wah, Delay, Pong Delay, Phrase Sampler, Reverb, and a Crossover for bi-amp applications. The Bass30 also includes a chromatic tuner, the Jam-A-Long™ function and a built-in expression pedal capable of controlling effects in real time. This Owner's manual is your guide to getting the most out of your Bass30. Please read it carefully, to get familiar with the controls of the Bass30. This will ensure years of musical satisfaction.

## Included Items

Your Bass30 was carefully assembled and packaged at the factory. Before proceeding any further please make sure the following items are included.

- 1 Bass30 Bass Guitar System
- 1 PS750 External Power Supply
- 1 Owner's Manual
- 1 Warranty Registration Card
- 1 Preset Card

Please save all packing materials, and take a moment to fill out the warranty registration card. It is your safeguard in the unlikely event that your Bass30 needs servicing. Please use the packing materials to return the unit if necessary.

## Features

- *Authentic Amp/Guitar Modeling*
- *Built-in Expression Pedal*
- *30 User/30 Factory Presets*
- *Up to 9 Effects at Once*
- *Stereo Outputs*
- *Chromatic Tuner*
- *Phrase Sampler*
- *Jam-A-Long™*
- *Headphone Output*
- *Bi-Amp Capabilities*

# SECTION ONE - Overview

## A Guided Tour of the Bass30 Front Panel

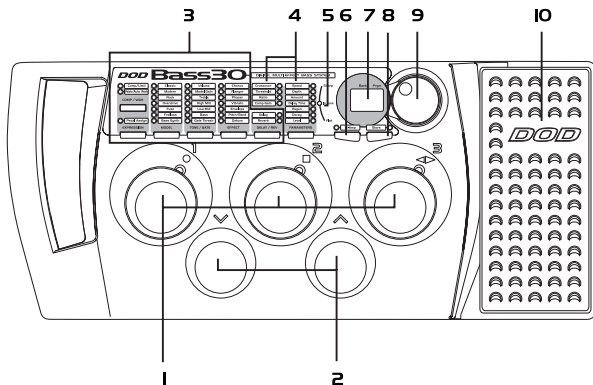

- 1. Preset Footswitches** - These switches provide access to the Bass30 user presets. They are also used to bypass the Bass30, access the Tuner, and perform various functions for the Phrase Sampler.
- 2. Bank Footswitches** - These two switches are used to advance or reverse the currently selected Bank. Either switch can also be used to exit the Phrase Sampler.

- 3. Effect Matrix** - These columns and buttons are used to select, bypass, and edit each specific effect group. The effects which are currently active within a preset are indicated by a lit LED. The button at the bottom of each column will select the effect group within the indicated column. Successive presses of the same button will advance to the next type of effect within that group. The currently selected effect will be represented by a flashing LED. The effect groups include Compression, Wah, Pedal Assign, Model, Tone/Gate, Effect, Delay, and Reverb.
- 4. Parameters** - These columns represent the various parameters of the Compressor, Limiter, Bass Synth, Effects, Delay, and Reverb groups which can be fine tuned to suit your application. When any of these groups are selected, their associated Parameter LEDs will light indicating they are available for editing. The Parameters are selected by using the button at the bottom of the Parameter columns. Successive presses of the Parameter button will advance to the next available Parameter (indicated by a flashing LED). Once the desired Parameter has been selected, its current value will be shown in the display (7), and can be adjusted by rotating the Data Wheel (9). The Parameter LEDs also serve as sharp and flat indicators when the Tuner is active.
- 5. Tuning LEDs** - When the Tuner is active, the Display (7) will show the note being played and the parameter LEDs will indicate whether you are sharp or flat. Parameter LEDs above the In Tune LED indicate that you are sharp and need to tune down. Parameter LEDs below the In Tune LED indicate that you are flat and need to tune up. Your note is in tune when the In Tune LED is the only one lit.
- 6. Bi-Amp** - This button is used to access the Crossover frequency for Bi-Amp applications. Once this button

is pressed, the display will either show two dashes - - indicating that the Bi-Amp function is bypassed, or the currently selected crossover frequency if the Bi-Amp function is active. Rotate the Data Wheel to select the crossover frequency, or change the Bi-Amp status. The LED will remain lit when the Bi-Amp function is active. See Page 25 for more on Bi-Amping

- 7. Display** - The Display serves three functions. In performance mode, the Display will indicate the Bank and Preset that is currently active. In edit mode, the Display will show the status or value of the effect or Parameter being edited. In Tuner mode, the display will show the note played.
- 8. Store** - After editing a Preset, your modifications must be stored if you want the Bass30 to remember the changes that you made. When you change any aspect of a Preset, the Store LED will light indicating that you need to use the Store button to save the change.
- 9. Data Wheel** - This knob is used to select the Preset in performance mode, and to increase or decrease the value of a Parameter in edit mode. It is also used to change the tuning reference in Tuner mode.
- 10. Expression Pedal** - This pedal can be assigned to control one of 13 different Parameters in real time for each Preset. As you rock the pedal back and forth, the value of the assigned Parameter will change giving you expressive control over the effects.

## Rear Panel

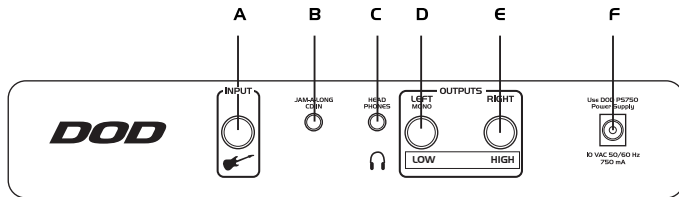

**A. Input Jack** - Connect your instrument to this jack.

**B. Jam-A-long™** - This is used for playing along with your tapes and CD's. Use a stereo cable with 1/8" stereo plugs to connect the headphone output of your tape or CD player to this jack.

**C. Headphone** - This jack is used for connecting a pair of stereo headphones to the Bass30.

**D. Left Output** - Connect from this jack to the input of your amplifier for mono applications, or to the left channel of a stereo power amp for stereo applications, or to the power amp driving the low frequency speakers for bi-amp applications.

**E. Right Output** - Connect from this jack to a second amplifier, the right channel of a stereo power amp for stereo applications, or the power amp driving the high frequency speakers for bi-amp applications.

**F. Power Jack** - Connect only the PS750 power supply to this jack.

## Getting Started

The Bass30 is ready for you to plug in and play. It already has a variety of sounds programmed into both the 30 factory and 30 user Presets. You will find that the User Presets are exact duplicates of the Factory Presets. The Factory Presets are permanently written into the Bass30 and cannot be changed. The User Presets can be overwritten with your sound creations as many times as you choose.

## Making Connections

The Bass30 can be run in mono, stereo, or bi-amp configurations. The following connections outline the set up for all three applications. These steps should be performed in the order that are listed here. Make sure that you do not connect the power to the Bass30, or turn on the power to your amplifier until the completion of these steps.

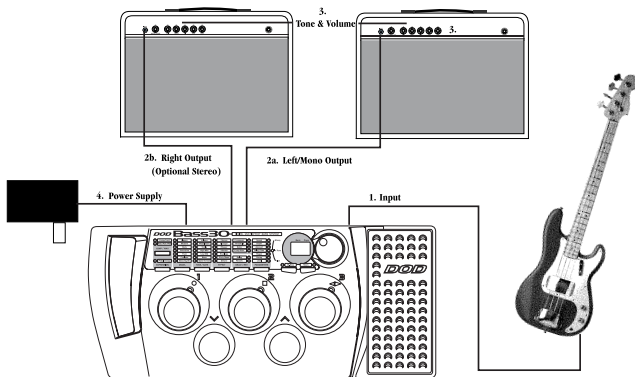

1. Connect your instrument to the Bass30 input jack.
- 2a. **(mono)** Connect the left output to the input of your amplifier, or line input of a mixing console.
- 2b. **(stereo)** Connect the left and right outputs to the inputs of two amplifiers, or two line inputs of a mixing console.
- 2c. **(bi-amp)** Connect the left output to the power amp driving the low frequency speakers, and the right output to the power amp driving the high frequency speakers.
3. Set the tone controls of the amplifier(s) or mixing console to the flat position. If you are running stereo into a mixer set the pan controls hard left and hard right. Turn your amplifier or mixer's volume level down.
4. Apply power to the Bass30 by connecting the PS750 from the power jack to an AC outlet.
5. Turn the power switch of your amplifier(s) or mixer to the "on" position.
6. Begin playing and gradually increase the amplifier(s) or mixer's volume until the desired level is achieved.

## **SECTION TWO - About the Bass30**

### **Performance Mode**

The Performance Mode of the Bass30 enables you to use the numbered footswitches or Data Wheel to change from one Preset to another, the Bank Footswitches to change Banks, and the Expression Pedal to vary the amount of the assigned Parameter. From the Performance mode you may also bypass the Bass30 by pressing the active Preset's Footswitch, or access the built-in chromatic tuner by pressing and holding the active Preset's Footswitch.

### **Selecting a Preset**

Accessing the Presets may be done by using the Data Wheel or Footswitches. The Bass30 has 30 Factory and 30 User Preset locations. The Presets in the Bass30 are arranged in 10 Banks with 3 Presets in each bank. The User Presets are indicated by a decimal point in the bottom right corner of the Display. The Factory Presets do not have the decimal point.

### **Data Wheel**

While in Performance mode, the Data Wheel is used to select Presets. Simply rotate the Data Wheel until the desired preset number is shown in the Display. The Data Wheel will scroll through all of the Presets in the User Banks, and then scroll through all of the Presets in the Factory Banks. If you continue to rotate the Data Wheel, the Bass30 will “wrap around” and access the User Presets again. In edit mode, rotating the Data Wheel will change the status or value of the selected effect or parameter. In Tuner mode, rotating the Data Wheel will change the tuning reference. In Bi-Amp mode, rotating the Data Wheel will change the Bi-Amp crossover frequency.

## Footswitches

The footswitches are also used to select Presets. The Bank Up and Bank Down footswitches advance or reverse Banks, and the 1-3 numbered footswitches select the Preset within the active Bank. Successive presses of the Bank Up or Down switches will advance or decrease to the next Bank of Presets. Each time a new Bank has been selected, the numbered footswitches will flash indicating that you need to select a Preset using these footswitches in order to activate that Bank. If no preset is selected within 5 seconds, the Bass30 will revert to the currently active Bank and Preset. Once you have selected the desired Bank, simply use the numbered footswitches to select one of the three possible Presets. For instance, if you want to access User Preset 63, press the Bank Up or Down switch repeatedly until the display shows Bank 6. Then press the #3 footswitch to access Preset 3. The display will then show 63. The Preset footswitches are also used to bypass the Bass30. To bypass the Preset, press the currently active Footswitch. The display will show  $b^P$  indicating that it is bypassed. Press any numbered footswitch to return to the Preset.

**Note:** The footswitches will only activate the User Presets and Banks. To access the Factory Presets and Banks, you will need to use the Data Wheel and scroll above or below the last User Bank/Preset.

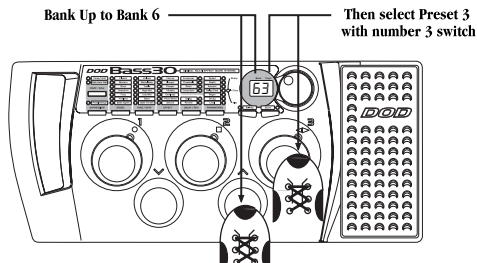

## Accessing the Tuner

The Bass30 includes a chromatic Tuner to quickly get your instrument in tune. To access the Tuner, press and hold the currently active Preset's Footswitch (the footswitch with a lit LED above it) until the letters **ET** appear in the display (abbreviation for tuner). You can then play any string on your bass. The display will show the note played, and the Parameter LEDs will light to let you know whether you are sharp or flat. Your note is in tune when the In Tune LED is lit. The LEDs above the In Tune LED indicate that you are sharp and need to tune down. The LEDs below the In Tune LED indicate that you are flat and need to tune up.

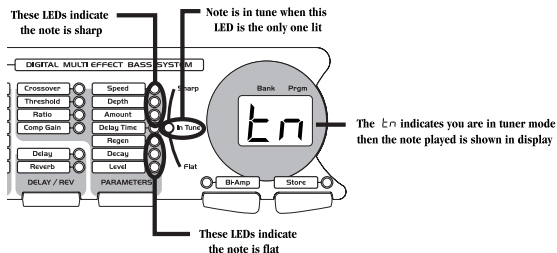

The tuning reference on the Bass30 has been set to A=440 (concert pitch) from the factory. You may change the tuning reference for drop tunings by rotating the Data Wheel at any time while in the tuner mode. Your tuning choices are **A** (standard tuning), **A $\flat$**  (1/2 step flat), **G** (whole step flat), and **G $\flat$**  (one and 1/2 steps flat). Pressing any Preset footswitch will exit the tuner mode and return you to the performance mode.

## Jam-A-Long™

The Jam-A-Long™ feature lets you connect a tape or CD player to the Bass30 and mix the music with your bass signal. Connect from the headphone output of your tape or CD player to the Jam-A-Long™ input on the rear panel of the Bass30 using a 1/8" stereo cable. Both the recording and your bass signal will feed into your amplifier allowing you to Jam-A-Long with your favorite artists.

**Warning: The Jam-A-Long™ input is not affected by the Bi-Amp function and will produce full range frequencies at both outputs.**

# SECTION THREE - Edit Mode

## Editing a Preset

The Bass30 allows you to edit the User Presets to your liking. You can change the effects that are used in the Preset, alter the values of the effect Parameters, or bypass an effect. This is a very simple process and gives you the ability to create custom sounds to suit your application or taste. You must start with an existing Preset. It is not possible to start with a blank Preset. Once you have selected a Preset as your starting point, you can select the effect type that you want and then fine tune the Parameters of the effects.

## User Interface

Choosing the type of effect that you want to use in a Preset is extremely easy. The Bass30 has been divided into groups of effects. Each effect group is accessed by a dedicated effect group button. Simply press the effect button that represents the effect group that you want to use, change, or bypass. The following describes the functions of each button in the user interface:

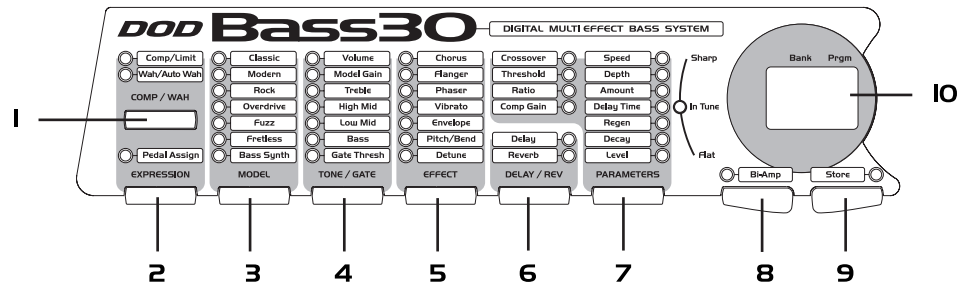

**1. Comp/Wah** - This button will access the Compressor/Limiter and Wah effects. Successive presses of this button will toggle between the Compressor/Limiter and the Wah. The selected effect is indicated by the flashing LED. The status of the selected effect can then be changed by rotating the Data Wheel. The Compressor contains 4 parameters available for adjustment. These parameters will light when the Compressor has been selected and may be accessed by using the Parameters button. Compression and Wah can be used simultaneously. See page 18 for a complete description of Compression and Wah effects.

**2. Expression** - This button is used to assign functions to the Expression Pedal. Pressing this button once will cause the Expression LED and the LED of the Parameter currently assigned to the Expression pedal to begin flashing. Rotating the Data Wheel will change the Expression Pedal's Parameter assignment. The new Parameter selection will be indicated by a flashing LED in one of the effects groups, or parameter section. Only one Parameter at a time can be controlled by the Expression Pedal. Successive presses of this button will allow you to edit the range of the Expression Pedal. See page 15 for more information on assigning the Expression Pedal.

**3. Model** - This button will access the Amp and Guitar Modeling section. The LED next to the currently selected Amp/Guitar Model will flash. Successive presses of the Model button will advance through all available Amp and Guitar Models. Only one Model can be used in each Preset. The Display will show the status of the Modeling section as either  $\square \square$ , or two dashes -- indicating bypass. Rotate the Data Wheel to change the status. See page 18 for a complete description of Amp/Guitar Models.

**4. Tone/Gate** - This button will access the Gain, and EQ of the selected Model, as well as Volume and Noise Gate. The selected Modeling Parameter will be indicated by a flashing LED. The Display will show the value of the selected Parameter. Rotating the Data Wheel will adjust the value. Successive presses of the Tone/Gate button will advance through these Parameters. A separate value for each Modeling Parameter can be stored to Presets. See the Modeling section on page 18 for a complete description of Tone adjustments and page 20 for the Noise Gate.

**5. Effect** - This button will access the Modulation and Pitch shifting effects. The currently selected effect in this group is indicated by a flashing LED. Successive presses of the Effect button will select a different type of effect within this group. The choices include: Chorus, Flanger, Phaser, Vibrato, Enveloped Flanger, Enveloped Phaser, Bass Enhancer, Pitch Shift or Pitch Bend, and Detune. Only one type of Effect from this group may be used at a time. The Display will show the status of the Effect section as either  $\square\square$ , or two dashes -- indicating bypass. The status can be changed by rotating the Data Wheel. If the Enveloped Effect is chosen, the Display will show an abbreviation for the type of Envelope Effect. One or more of the Parameter LEDs will light with each selection in the Effect group indicating Parameters which are associated with the selected Effect, and are available for further adjustment. Use the Parameter button to access the associated Parameters. See pages 20 and 21 for a complete description of these effect types.

**6. Delay/Reverb** - This button will access the Delay and Reverb effects. The selected effect type will be indicated by a flashing LED. Successive presses of the Delay/Reverb button will toggle between the two effects. The status of the selected effect and the current type of Delay and Reverb are shown in the Display. Rotating the Data Wheel will change the status and/or the type of Delay and Reverb. Both the Delay and Reverb can be used simultaneously. You will notice that one or more of the Parameter LEDs will light with each selection in this group. The lit Parameters are associated with the selected effect, and are available for further adjustment. Use the Parameter button to access the associated Parameters. See pages 21 and 22 for a complete description of Delay and Phrase Sampler, and page 23 for Reverb effects.

**7. Parameters** - This button accesses the Parameters associated with the Compressor/Limiter, Bass Synth, Effect group, Delay, and Reverb. The Parameter button will only work when one of these effect groups has been selected for editing. The lit LEDs indicate which Parameters are associated with the selected effect, and the currently selected parameter is indicated by a flashing LED. Successive presses of the Parameter button will advance through all Parameters available for the selected effect. The Display shows the value of the selected Parameter, and rotating the Data Wheel will change the value. See page 23 for a complete listing of parameters.

**8. Bi-Amp** - This button provides access to the Crossover frequency for Bi-amp Applications. The Crossover frequency can then be selected by rotating the Data Wheel. See page 25 for more information on Bi-Amping

**9. Store** - This button is used to save changes to Presets. The LED above this button will light when a change has been made to effects or parameters in a preset indicating that you need to perform the Store function in order to retain your changes. See page 17 for more information on storing procedures.

**10. Display** - While in edit mode, the Display will show the status of the selected Effect, or the value of the selected Parameter. When an effect is bypassed, the display will indicate bypass by showing two dashes --. Rotating the Data Wheel will re-engage the effect, or change the value of the selected Parameter.

## Expression Pedal Assignments

The Bass30 allows you to assign the Expression Pedal to control various Parameters in real time. Only one Parameter at a time can be assigned to the Expression Pedal. The procedure for assigning a Parameter to the Expression Pedal is as follows:

- 1.- Press the Expression button once. The Expression LED, and the LED of the Parameter currently assigned to the Expression Pedal begins to flash.
2. - Rotate the Data Wheel to select the Effect or Parameter you wish to assign. The selection will be indicated by a flashing LED in the effect group, or parameter section. The Display will show a number between 1 and 12 representing the 12 possibilities. Your choices include:

1 - Volume

2 - Wah

3 - Model Gain

4 - Bass Synth Speed

5 - Bass Synth Amount

6 - Bass Synth Level

7 - Modulation Speed

8 - Modulation Depth

9 - Bend Amount

10 - Modulation Level

11 - Delay Regeneration

12 - Delay Level

13 - Reverb Level

-- Not Assigned

Once the desired effect or Parameter has been selected, you can set minimum and maximum values for the Expression Pedal. These are stop points which limit the range of variance for the Pedal.

3. - Press the Expression button a second time to set the toe up value. The Display will alternate between showing  $\uparrow$  (toe up) and the value currently assigned. Rotate the Data Wheel to select the value that the Expression Pedal will reach in the toe up position.
4. - Press the Expression button a third time to set the toe down value. The Display will alternate between showing  $\downarrow$  (toe down) and the value currently assigned. Rotate the Data Wheel to select the value that the Expression Pedal will reach in the toe down position.

**Note: The Effect of the assigned Parameter must be active in order for the Expression Pedal to function.**

## Storing/Copying a Preset

Once you have edited a Preset to your liking, you must store the changes in order for the Bass30 to remember your settings. There are three steps to storing a Preset.

1. Press the Store button once. The Store LED will flash and the User LED lights. The flashing LED is asking you to select the Preset location where your changes will be stored.
2. Use the Data Wheel to select the User Bank and Preset location for this new sound to be saved.
3. Press the Store button again. The new sound is now saved in the location you selected.

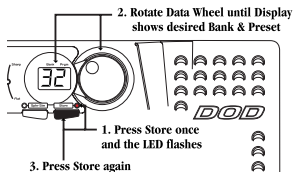

**Note:** This same procedure can be used to copy a Preset to a different User Preset location.

To abort the store function, press any footswitch.

## SECTION FOUR - Effects Definitions

**Compressor/Limiter** - A compressor is used to constrain the dynamics of an instrument. In other words, it sets a boundary for the volume the instrument will be able to reach. Compressing the dynamics of an instrument tends to provide a smooth, balanced output level of the instrument. Limiting uses the same principle as compression but is much more restrictive. When the compressor/limiter is selected, the display will show the status as one of the following:  $\square\square$  indicating the Compressor is active,  $\square\square$  indicating the Limiter is active, or  $--$  indicating bypass. The Compressor has 4 different parameters which can be accessed with the Parameters button once the compressor is selected and active. They are as follows: Crossover Frequency, Threshold, Ratio, and Gain. The Limiter has one parameter: Threshold. See page 23 for parameter definitions.

**Wah and AutoWah** - Wah is a classic effect which provides a sweepable filter giving the instrument a vocal type sound. The regular Wah is controlled by the Expression Pedal. AutoWah is a Wah effect which is automatically controlled based on how hard you play. The Bass30 includes 3 types of Wah (  $\uparrow$  - Classic Wah,  $\uparrow^2$  - Treble Wah,  $\downarrow$  - Bass Wah), and 6 types of AutoWah ( $\uparrow$  -  $\uparrow^2$  - upward sweeping AutoWah with a progressing degree of signal strength required to trigger the AutoWah,  $\downarrow$  -  $\downarrow^2$  - downward sweeping AutoWah with a progressing degree of signal strength required to trigger the AutoWah).

**Modeling** - Modeling is a new technology which emulates the sounds and frequency response of different types of amplifiers and guitars. The modeling section in the Bass30 offers 2 bass distortions: Overdrive, and Fuzz, 3 great bass amps: Classic (based on an Ampeg SVT); Modern (based on a Trace Elliot); and Rock (based on an SWR), 5 variations of a fretless bass, and 12 variations on a synth bass. Each Amp Model as well as the distortions contain 7 adjustable parameters: Gain (the amount of distortion), High EQ (treble), High-Mid EQ (upper end of the mid range tone), Low-Mid EQ (lower end of the mid range tone), Low EQ (bass), Gate Threshold (see noise gate definition), and Volume (Preset level).

Ampeg, Trace Elliot, and SWR are trademarks of their respective companies and are in no way associated with DOD Electronics.

**Fretless** - The Fretless bass simulations in the Bass30 shape the attack of your instrument by combining an auto swell on the high frequencies, a subtle wah on the mid range, with detailed equalization. The choices of fretless simulations range from -- (bypass), F 1 (fretless into an Ampeg SVT), F 2 (Fretless into a Trace Elliot), F 3 (Fretless into a SWR), F 4 (a bowed upright bass), and F 5 (a plucked upright bass). The Gain parameter controls the amount of swell. The EQ and Gate controls operate the same as the Amp Models.

Ampeg, Trace Elliot, and SWR are trademarks of their respective companies and are in no way associated with DOD Electronics.

**Bass Synth** - The Bass Synth simulates the bass sounds found in many popular synthesizers. The Bass30 utilizes 4 different waveforms and 3 variations on each waveform. The waveforms include rectangle (r 1, r 2, and r 3), triangle (t 1, t 2, and t 3), saw-tooth (s 1, s 2, and s 3), and pulse width (P 1, P 2, and P 3). Two dashes -- indicate that the Bass Synth is bypassed. Variation 1 is an upward sweeping envelope, variation 2 is a downward sweeping envelope, and variation 3 is a manually controlled envelope (4 - Bass Synth Speed must be assigned to the Expression Pedal in order for any of the third variations to work). The Bass Synth incorporates the use of synthesized waveforms, sub-harmonics, and an octave shift into the sound. There are 10 parameters associated with the Bass Synth: Gain (fundamental frequency mix), Treble EQ (octave mix level), High-Mid EQ (high tone control), Low-Mid EQ (low tone control), Bass EQ (the sub-harmonic mix level), Speed (rate of envelope sweep), Depth (intensity of wah or envelope sweep), Amount (percentage of duty-cycle for pulse width wave forms), Level (Bass Synth mix), and Gate (see noise gate definition). When the Bass Synth is active, the Compression, Wah, and Auto Wah are disabled.

**Noise Gate** - A Noise Gate keeps unwanted noise from being heard when you are not playing. When the gate is closed, it will not allow ambient noise to come through. A noise gate uses a threshold, which is the volume level required to open the gate. If the threshold is set too high, requiring a stronger signal than your bass is producing, the gate will not open, and no sound will be heard. The gate on the Bass30 is also used for auto volume swells. When you have selected the gate to act as an auto volume swell, you can play a note on your bass and the sound will automatically fade in. There are 10 Gate Threshold settings (1 - 10 with 1 being the most sensitive and progressing to 10 requiring the strongest level to open), and 9 Auto Swell settings (1 - 9 with 1 opening with a weak signal and fading in quickly, progressing to 9 requiring a stronger signal and fading in slower).

**Chorus** - A Chorus is an effect that thickens to your bass signal. A Chorus works by splitting your signal into two signals, adding a short delay to one of the signals, then changing the delay time at an even rate and mixing it back with the original. This results in a slight fluctuation in pitch of the delayed signal giving the thickness as if two bass guitars were playing together.

**Flange** - A Flanger is similar to a Chorus as far as what it is technically doing, but it sounds very different. It adds a “whooshing up, and down” sound to your bass by incorporating regeneration into the delayed signal.

**Phaser** - A Phaser is an effect that splits the incoming signal into two signals, and changes the phase of one signal. This phase is changed at an even rate, and mixed back in with the original sound. The changing phase mixed with the original signal causes different frequencies to be canceled, resulting in a warm, twisting effect added to your instrument.

**Vibrato** - Vibrato is an effect that modulates the frequency of your signal at a steady rate. This results in a pronounced fluctuation in pitch.

**Envelope** - The Envelope Effects alter your sound based upon how hard you play. The softer that you play, the less intense the sweep of the FL (Flanger) or PH (Phaser) effect will be. The harder that you play, the more intense the sweep will be.

**Pitch** - When Pitch/Bend is selected, the display will show one of three different types of Pitch Shifting which are selectable by rotating the Data Wheel. The types include:  $P\text{E}$  (Pitch Shift),  $b\text{r}$  (Pitch Bend), and  $b\text{E}$  (Bass Enhancer). Pitch shifting makes a copy of your signal, then shifts it to a different pitch. This results in two different notes playing together. The Amount Parameter determines the interval of the shifted note. The interval choices include:  $1\text{d}$  (one octave down),  $-5$  (a fifth below),  $-3$  (a third below),  $b3$  (a flatted third above),  $3$  (a third above),  $4$  (a fourth above),  $5$  (a fifth above), and  $1\text{u}$  (one octave up). Pitch Bend is an effect that will require the expression pedal. When the expression pedal is assigned to this effect, you can bend the pitch of your note by rocking the expression pedal up and down. As you rock the pedal forward, the note will bend either up or down depending on the pitch interval you have selected with the Amount Parameter. The Amount Parameter determines the possible bend ranges and choices include:  $1\text{d}$  (1 octave down with no dry signal),  $-4$  (a fourth below with no dry signal),  $-2$  (a second below with no dry signal),  $4$  (a fourth above with no dry signal),  $5$  (a fifth above with no dry signal),  $1\text{u}$  (one octave up with no dry signal),  $24$  (a second above to a fourth above with dry signal), and  $34$  (a third above to a fourth above with dry signal). Bass Enhancer mixes a sub harmonic with your original signal. The Amount Parameter selects the frequency of the low pass filter in the effect.

**Detune** - Detuning is an effect that uses pitch shifting technology, but does not shift the pitch a full note. It shifts the pitch slightly out of tune with your note, and mixes it back with the original. The Amount Parameter is available with this effect and determines the detuning applied which is measured in cents (100 cents = 1 semitone). The Amount is variable from  $-18$  (18 cents below) to  $18$  (18 cents above).

**Delay** - A Delay records a short passage, and then repeats it a moment later. You can repeat the passage once, or several times. The Bass30 offers four types of delay:  $\text{tR}$  (tape delay),  $\text{dL}$  (delay),  $\text{PP}$  (ping pong delay), and  $\text{Ph}$  (phrase sampling). Tape Delay emulates delays using a tape to record, causing each repeat to deteriorate from the original sound. The Delay setting provides clear, concise repeats. The Ping Pong setting will “bounce” repeats from left to right in stereo. See the next section for a description of the Phrase Sampler.

**Phrase Sampler** - The Phrase Sampler will allow you to record up to a 6 second phrase, overdub over the phrase, and then repeat them indefinitely. Operation of the Phrase Sampler is accomplished by using the Preset Footswitches and the Expression Pedal. Markings next to the Footswitches indicate the Phrase Sampler functions for each. When a Preset has been selected which has the Phrase Sampler selected in the Delay module, rocking the expression pedal from the toe up position to the toe down position will activate the Phrase Sampler functions. The Preset Footswitch LEDs will flash indicating that you are in Phrase Sample Mode. Begin the recording by pressing the Record (Preset 1) Footswitch. When you are finished recording the phrase, press the Stop (Preset 2) Footswitch which will automatically set the start and stop points for the Phrase. Record can then be pressed again to add layers on top of the previously recorded phrase. Pressing the Play (Preset 3) Footswitch will start the Sample from the beginning. The Expression Pedal will control the number of times that the phrase will repeat when assigned to delay regeneration. With the Expression Pedal in the toe up position, the phrase will repeat once. With the Expression Pedal in the toe down position, the phrase will repeat infinitely. In order to overdub one phrase on top of another, you must press the Record (Preset 1) Footswitch again after one phrase has been sampled (there must be some delay regeneration in order to overdub), and record the additional phrase. The Phrase can be stopped by pressing the Stop (Preset 2) Footswitch. Pressing the Stop footswitch after the phrase is already stopped, will erase the recorded phrase. Because the Phrase Sampler utilizes the Preset Footswitches for control, these switches will not change Presets after the Phrase Sampler has been activated. In order to exit the Phrase Sampler mode and select a new Preset, press the Bank Up or Bank Down footswitch, and then select the new Preset with the Preset Footswitches.

**Reverb** - Reverb simulates different acoustic environments. Reverb can make you sound as though you are playing in a big empty room, or a small tiled bathroom. It adds ambiance to your instrument by mimicking the characteristics of sound bouncing off walls. The Bass30 is capable of emulating three different environments. They are *PL* (plate), *HA* (hall), and *AR* (arena). Plate is the way recording studios used to produce reverb. They would attach a driver to a metal plate and then send the signal into the driver which would make the plate vibrate. Hall is intended to simulate a small acoustic echo chamber, and Arena is the largest environment, sounding as if you are playing in a large arena.

## Parameter Definitions

The following is a list of the Parameters available for editing and a description of how each Parameter will affect the sound of the corresponding effects.

**Crossover** - The Compression Crossover Parameter determines the range of frequencies which will be compressed. Frequencies above the selected range will pass through uncompressed. Crossover ranges from *5* (60 Hz) to *2.0* (2000 Hz), and *FL* (all frequencies compressed).

**Threshold** - The Compression Threshold Parameter tells the compressor when to start compressing. It is the strength the incoming signal must reach before the compression begins. When the Threshold is exceeded, the compressor applies the selected ratio to the signal. Threshold ranges from *40* (-40 dB where weak signals will be compressed) to *0* (0 dB requiring strong signals in order to compress) and is adjustable in increments of 2 dB.

**Ratio** - The Compression Ratio tells the compressor how much compression to apply once the threshold has been exceeded. A ratio of 3:1 means that when the threshold has been exceeded by 3 dB, only 1 dB of increased signal will be allowed to come out. Ratio ranges include: *1.0* (1:1), *1.1* (1.1:1), *1.2* (1.2:1), *1.4* (1.4:1), *1.7* (1.7:1), *2.1* (2.1:1), *3.0* (3:1), *5.6* (5.6:1), and *∞* (infinity:1).

**Gain** - The Compressor Gain adjusts the output volume from the compressor. This parameter is used to balance the volume levels which may be lessened due to the compression effect. Gain ranges from 0 (no gain change) to 15 (15 dB of boost) in 1 dB increments.

**Speed** - The Speed control adjusts how fast the Chorus, Flanger, Phaser, Vibrato, Enveloped Phase, or Enveloped Flange will sweep back and forth. It can be used to vary these effects between a fast shimmering type of sound, and a slow gradual sweeping. It also controls the speed of the Bass Synth envelope. Speed ranges from 0 (slow) to 99 (fast).

**Depth** - The Depth adjusts the intensity of the Bass Synth, Chorus, Flanger, Phaser, Vibrato, or Enveloped effects. Depth ranges from 0 (minimum intensity) to 99 (maximum intensity).

**Amount** - The Amount selects the interval of the Detune, Pitch Shift, or Pitch Bend effects. The Bass Synth uses the Amount parameter to control the percentage of duty-cycle for pulse width wave forms. See the description of these effects for their Parameter ranges.

**Delay Time** - The Delay Time adjusts the length of time between repeats of the Delay. The Delay Time is variable in three ranges from 1 millisecond to 3 seconds. The ranges are as follows: 1 through 99 (1 millisecond to 99 milliseconds in one millisecond increments), 100 through 990 (100 milliseconds to 990 milliseconds in ten millisecond increments), and 1.0 to 3.0 (1 second to 3 seconds in 100 millisecond increments). Note that the decimal point is what differentiates between the three ranges.

**Regen/Fback** - The Regeneration adjusts the number of times that the Delay will repeat. It will also increase the amount of whooshing heard in the Flanger and Phaser. The Feedback/Regeneration ranges from 0 to 99.

**Decay** - The Decay adjusts the length of time the Reverb will be heard. This is perceived as how “big” of a room the Reverb effect is simulating. Decay ranges from 0 (smallest environment) to 99 (largest environment).

**Level** - The Level will adjust the overall strength of effects in the Preset. The Level ranges from 0 to 99.

**Bi-Amp** - Bi-Amping is a term used to describe the process of using a two way crossover to add definition to your signal by separating the high frequencies from the low frequencies, and using separate amps and speakers to drive each frequency range. The Bass30 includes a programmable Crossover, and utilizes the Left/Mono, and Right Outputs for the Low and High Frequency Outputs. Once the Bi-Amp button is pressed, the LED will flash indicating that the Crossover frequency has been selected for editing, and the Display will show the current Crossover frequency. Rotate the Data Wheel to select the desired frequency for separation. All frequencies below the selected Crossover point will be sent to the Left/Mono Output, and frequencies above will be sent to the Right Output. This is a global function and will affect your instrument on every preset. Crossover Frequencies range from 6 (60 Hz.) to 20 (2000 Hz.). Pressing the Bi-Amp button again, or any other effect button will exit the Crossover edit mode, however, the Bi-Amp LED will remain lit if the Bi-Amp mode is active.

**Warning: The Bi-amp function does not affect the Jam-A-Long input. The Jam-A-Long input will produce full range frequencies at both outputs.**

## SECTION FIVE - Tutorial

### Creating a Preset

Suppose you want to create a Preset that has medium Compression, Classic Amp Modeling with Medium Gain and boosted highs and lows on the EQ, a low Threshold setting on the Noise Gate, a slow medium Chorus, no Delay, and a Hall Reverb. Let's also suppose that you wanted the Expression Pedal to control a classic Wah. The steps outlined below will guide you through creating this Preset.

**Step 1. Adjust the Compression** - Press the Comp/Wah button. The LED next to Compressor will begin to flash, and the LEDs next to the Compression Parameters will light. The Display will show the current status of the Compressor. If the Display indicates that the Compressor is bypassed (two dashes --), rotate the Data Wheel until the Display shows  $\square \square$  (indicating the compressor is active). Press the Parameters button once to access the Compression Parameters. The LED next to Crossover will blink indicating that the Compressor's Crossover Parameter has been selected. Since we want a medium compression setting, rotate the Data Wheel to select the Crossover frequency of 25 which means that frequencies under 250 Hertz will be compressed, but all other frequencies will not. Press the Parameters button again and the LED next to Threshold will flash. Rotate the Data Wheel to select a Threshold value of about 20. Press the Parameters button again and the LED next to Ratio will flash. Rotate the Data Wheel again to select a ratio of 3.0 (3:1) which is a typical ratio for the bass guitar. Press the Parameter button one more time and the LED next to Gain will flash. Use the Data Wheel to match the compressor's volume level to the level when the Preset is bypassed.

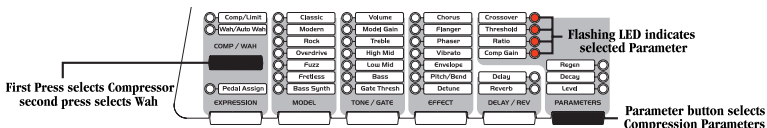

**Step 2. Select the Wah Type** - Since the Wah effect is in the Comp/Wah section, press the Comp/Wah button again. The LED next to Wah will begin to flash. Rotate the Data Wheel until the Display shows the number 1 (representing a classic wah).

**Step 3. Assign the Expression Pedal to Wah** - Press the Expression button. The LED next to Pedal Assign begins to flash. If the Expression Pedal is currently assigned to a Parameter, the assigned Parameter's LED will flash also. Rotate the Data Wheel until the LED next to Wah is flashing with the Pedal Assign LED (this should correspond to a number 2 in the Display).

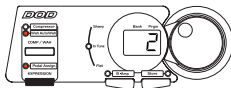

Press Expression and rotate Data Wheel until Display shows 2 indicating Wah

**Step 4. Select the Amp/Guitar Model** - Press the Model button. An LED next to the currently selected Amp Model will begin to flash. Continue to press the Model button until the LED next to “Classic” is lit. If the Amp/Guitar Modeling is bypassed (indicated by two dashes -- in the Display), rotate the Data Wheel until the Display shows □□.

**Step 5. Adjust the Tone/Gate Parameters** - In this sample Preset, we wanted medium gain, and boosted bass and treble. Press the button in the Tone/Gate column. The LED next to Volume will begin to flash. This parameter is a matter of personal taste, but for the sake of this example let's set this to about 85 by rotating the Data Wheel. Press the Tone/Gate button again and the LED next to Gain will begin to flash. Rotate the Data Wheel until the Display shows 75. Press the Tone/Gate button again and the LED next to Treble will flash. Rotate the Data Wheel until the Display shows 4. Press the Tone/Gate button again and the LED next to High Mid flashes.

Rotate the Data Wheel until the Display shows  $\square$ . Press the Tone/Gate button again and the LED next to Low Mid flashes. Rotate the Data Wheel until the Display shows  $\square$ . Press the Tone/Gate button again and the Bass LED will flash. Rotate the Data Wheel until the Display shows  $\square$ . Press the Tone/Gate button one more time and the Gate LED flashes. Rotate the Data Wheel until the Display shows  $\square$ .

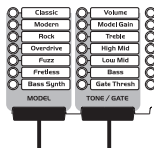

Select Classic as the Amp Model then adjust Gain, Tone and Gate

**Step 6 Select the Chorus Effect** - Press the Effect button until the LED next to Chorus is flashing. If the Chorus is bypassed (indicated by two dashes -- in the Display), rotate the Data Wheel until the Display shows  $\square \square$ . You will notice that the Parameter LEDs next to the words “Speed,” “Depth,” and “Level” are now lit. This indicates that these three Parameters are associated with the Chorus, and available for adjustment. Press the Parameter Edit button once and the Speed LED will begin to flash indicating that you are about to edit the Chorus Speed. The Display will show the current value for the Chorus Speed. Since our sample Preset calls for a slow medium Chorus, use the Data Wheel to set the Speed value to  $\square$ . Press the Parameter button again and the Depth LED flashes. Rotate the Data Wheel until the Display shows  $\square \square$ . Press the Parameter button again and the Level LED flashes. Rotate the Data Wheel until the Display shows  $\square \square$ .

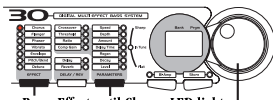

Press Effect until Chorus LED lights then use Parameter button and Data Wheel

**Step 7 Turn the Delay off** - Our Sample Preset called for no Delay to be used. So, press the Delay/Rev button and the LED next to Delay will flash. Rotate the Data Wheel counterclockwise until the Display shows two dashes -- indicating that Delay is bypassed.

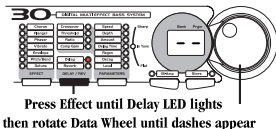

**Step 8 Select the Reverb** - Our sample preset called for a Hall type Reverb. Press the Delay/Rev button again and the Reverb LED will flash. Rotate the Data Wheel until the display shows *HR* for Hall. The Parameter LEDs next to the words Decay and Level light indicating that these parameters are available for Reverb adjustment. Press the Parameter button and the Decay LED will flash. Rotate the Data Wheel until the Display shows *50*. Press the Parameter button again and the Level LED will flash. Rotate the Data Wheel until the Display shows *50* as the Reverb Level.

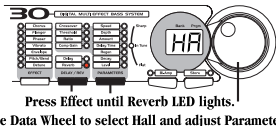

**Step 9 Store the Preset** - All that is left to do now is to store our new preset, otherwise the Bass30 will forget the changes that we have made. Press the Store button once. The Store LED will flash and the Display shows the Preset used before we edited our effects. Rotate the Data Wheel to select the User Preset location to store this new sound. Once the desired location is in the Display, press the Store button again and the changes will be saved.

**Congratulations! You have successfully created a new Preset.**

## SECTION SIX - Other Stuff

### Resetting the Bass30

This function restores all Presets to their original settings from the factory.

**Caution!** This procedure will overwrite and reset **ALL** User Presets in the Bass30 memory. Be sure you want to erase the memory and start fresh before continuing with this procedure.

1. Disconnect the power from the rear panel of the Bass30.
2. Press and hold the Compressor, and Model select buttons simultaneously.
3. Reconnect the power while continuing to hold the Compressor and Model buttons until the display shows  $r5$  indicating it has reset.

After the reset has occurred, The Bass30 will ask you to calibrate the Expression Pedal. The Display will read  $\downarrow$  (toe up). Rock the expression pedal back to the toe up position and press the flashing number 1 footswitch. The display now reads  $\downarrow$  (toe down). Rock the pedal forward to the toe down position and press the flashing number 3 footswitch. The expression pedal is now calibrated for use with all presets.

If an  $E_r$  shows in the Display, an error has occurred in the Pedal Calibration and the Bass30 will repeat the Calibration prompts asking you to repeat steps 3 and 4.

The Expression Pedal can be disabled by pressing and holding the Expression button down for a few seconds.

## Calibrating the Expression Pedal

If the Expression Pedal ever has problems with controlling parameters through their full range, it may be necessary to re-calibrate it. Follow these steps for Expression Pedal calibration:

1. Disconnect the power from the Bass30.
2. Press and hold the Expression button and reconnect the power. Continue holding the Expression button until the display shows  $\text{E}r$ , then release it.
3. When the display reads  $\text{E}u$ , rock the pedal back to the toe up position and press the flashing number 1 Footswitch.
4. The display now reads  $\text{E}d$ . Rock the Expression Pedal forward to the toe down position and press the flashing number 3 Footswitch.

The expression pedal is now calibrated for use with all presets.

If an  $\text{E}r$  shows in the Display, an error has occurred in the Pedal Calibration and the Bass30 will repeat the Calibration prompts asking you to repeat steps 3 and 4.

The Expression Pedal can be disabled by pressing and holding the Expression button down for a few seconds.

### ***Maintenance and Service***

The Bass30 is a maintenance free device. There are no user serviceable parts inside of the unit. Opening the chassis will void your warranty. All service and repair must be performed by an authorized DOD service center. Should a problem arise with your Bass30, contact your local DOD dealer for return/repair procedures.

# **SECTION SEVEN - Appendix**

## **Warranty**

1. The warranty registration card must be mailed within ten days after purchase date to validate the warranty of this DOD product.
2. DOD warrants this product when used solely within the U.S. to be free from defects and workmanship under normal use and service.
3. DOD Electronics liability under this warranty is limited to repairing or replacing defective materials that show evidence of defect, provided the product is returned through the original dealer, where all parts and labor will be covered up to a period of one (1) year. The company shall not be responsible for any consequential damage as a result of the products use in any circuit or assembly.
4. Proof of date of purchase is considered to be the burden of the consumer
5. DOD reserves the right to make changes in design or make improvements upon this product without incurring any obligation to install the same on **PRODUCTS PREVIOUSLY MANUFACTURED**.
6. The foregoing is in lieu of all other warranties, either expressed or implied, and DOD neither assumes nor authorizes any person to assume any obligation or liability in connection with the sale of this product. In no event shall DOD or its dealers be liable special or consequential damages or from any delay in the performance of this warranty due to causes beyond their control.

## Specifications

**Input:** 1/4" unbalanced

**Input Impedance:** 500 k Ohms

**Max Input Level:** 7.6 dBV

**Output:** 2 - 1/4" unbalanced

**Output Impedance:** 10 Ohms

**Max Output Level:** 11 dBV

**Headphone:** 1/8" Stereo TRS

**Headphone Output Impedance:** 10 Ohms

**A/D:** 64 x oversampling, 24 bit delta sigma

**DSP:** 24 bit

**Power Supply:** 10 volts AC, 780 mA (PS750)

**Power Consumption:** 5.5 watts

**Memory:** 30 user/30 factory

**Effects:** Frequency Selective-Fully Programmable Compression, 5 Amp Models, 5 Fretless Bass, and 12 Bass Synth Models, 4 band EQ, Noise Gate, Chorus, Flange, Vibrato, Phaser, Pitch Shift, Pitch Bend, Bass Enhancer, Detune, Enveloped Flange, Enveloped Phase, Wah, AutoWah, Delay, Phrase Sampler, Reverb, Bi-amp Crossover.

**Simultaneous Effects:** up to 9

**Dimensions:** 17" L x 8" W x 2.75" H

**Weight:** 3.7 lbs.

# Bass30

AMP MODELING  
DIGITAL MULTI-EFFECT  
BASS SYSTEM

DOD Electronics Corporation  
8760 S. Sandy Parkway  
Sandy, Utah 84070  
PH (801) 566-8800  
FAX (801) 566-7005

International Distribution  
8760 S. Sandy Parkway  
Sandy, Utah 84070 USA  
PH (801) 568-7642  
FAX (801) 568-7638

DOD and Bass30 are trade marks of the  
Harman Music Group Inc.

Copyright Harman Music Group

Printed in the USA 10/99

Manufactured in the USA

Bass30 Owners Manual I8-6329-A

Please visit DOD on the World Wide Web

at:

<http://www.dod.com>

# DOD

**H** A Harman International Company